

ComAnt[®] Communications Antennas

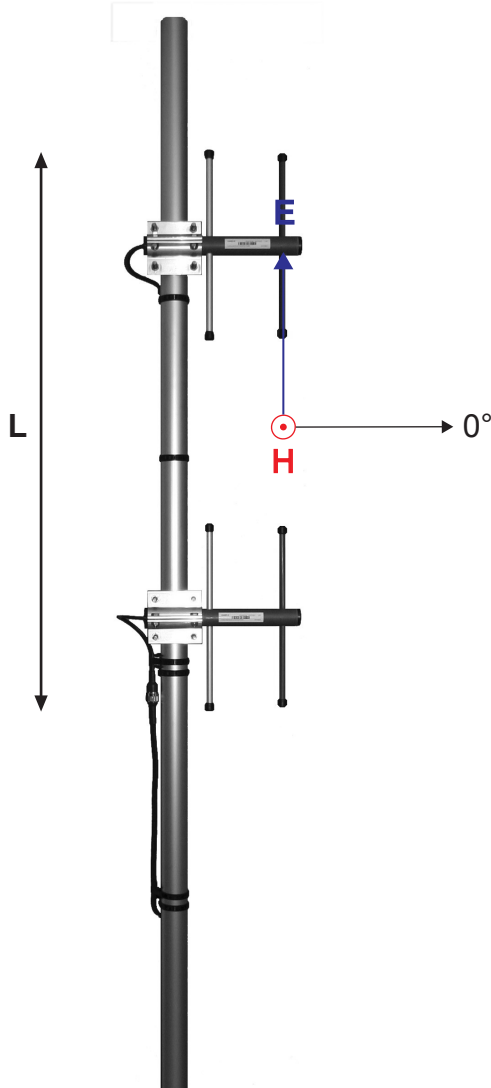

FREQUENCY INDEPENDENT DATA

Description:	directional stacked yagi array, field adjustable pattern, optional beam tilting
Frequency:	135-145 MHz, 144-156 MHz, 154-166 MHz, 163-177 MHz, 221-239 MHz, 326-353 MHz, 336-364 MHz, 365-395 MHz, 380-410 MHz, 405-440 MHz, 440-475 MHz, 830-890 MHz, 880-960 MHz
Impedance:	50 ohm
Gain:	9 dBi
H -3 dB:	178°
E -3 dB:	27°
F/B:	11 dB
Polarization:	vertical/horizontal
Connector:	N-female/TNC-female
VSWR:	< 1.5
Radome:	UV resistant ABS/FG, RAL 7012, PU foam filling copper
Radiator:	
Passive elements:	coated aluminium
Attachment:	Ø 35-60 mm, aluminium alloy bracket, stainless steel V- bolts and self-locking nuts
Lightning protection:	DC-short circuited
Temperature:	-40°C - +80°C
IP:	67

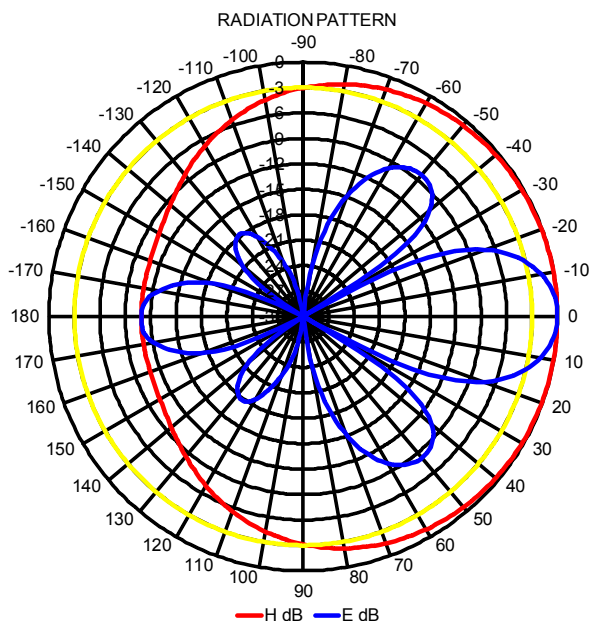

CAS2 DIRECTIONAL STACKED YAGI ARRAY